

The importance of design & specification for the forehearth & distributor

David Parkinson
Managing Director
Parkinson-Spencer Refractories Ltd



Parkinson-Spencer Refractories Ltd

4 design elements

1. Residence time
2. Head loss
3. Cooling capacity
4. Automation

These 4 design elements can make a big difference to the successful operation of a forehearth/distributor system.



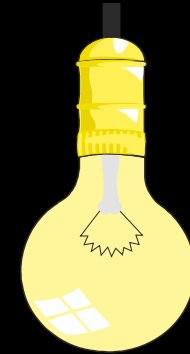

Ignorance of these design elements is like designing in darkness.

Result

- **poor production efficiency**
- **inconsistent gob weight**
- **inability to meet required range of gob temperatures**
- **inability to meet required range of tonnages**
- **poor fuel economy**
- **poor glass quality**

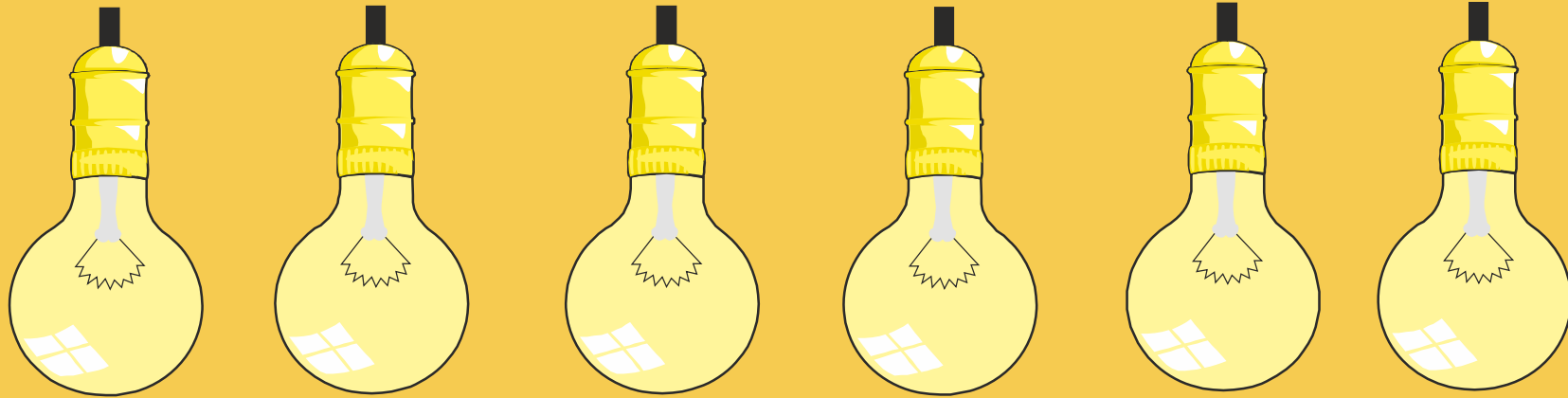

With good design the outcome can be clearly seen.

Result

- **good production efficiency**
- **consistent gob weight**
- **ability to meet required range of gob temperatures**
- **ability to meet required range of tonnages**
- **good fuel economy**
- **good glass quality**

1st design element - Residence time



- A simple design tool useful for guidance.
- A calculation of how long the glass takes to pass through the forehearth.
- For flint glass typical residence times should be between 40–120 minutes.
- For coloured glass typical residence times should be between 50–120 minutes.

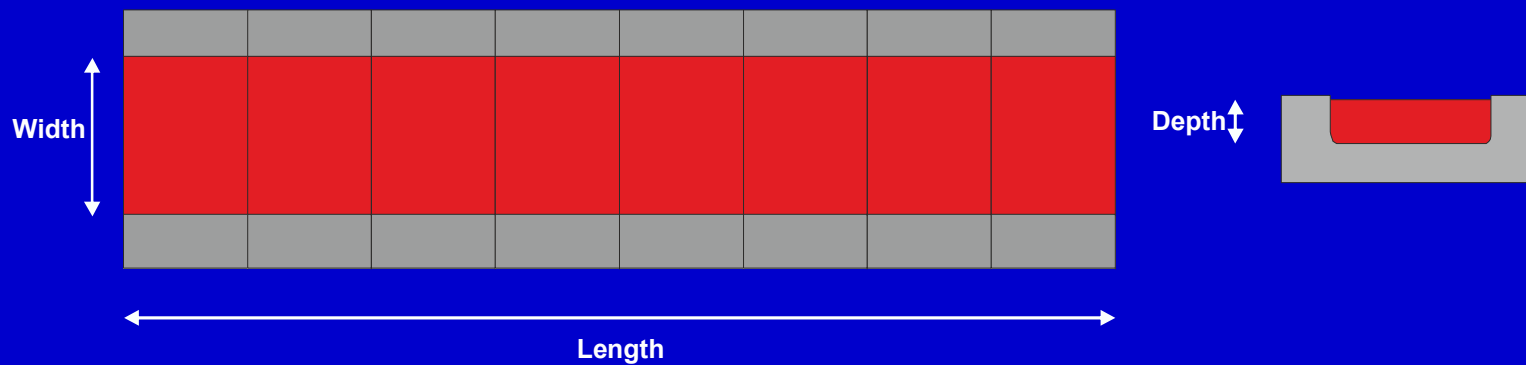

Residence time



- Too little residence time means that the glass cannot be properly cooled and conditioned for the required tonnage.
- Too much residence time means that energy has to be put back into the forehearth/distributor to maintain the required temperature.

However residence time takes no account of the heating or cooling capability of the forehearth or distributor system.

2nd design element - Headloss

Headloss is the loss of glass level along the forehearth from the entrance to the spout. It is a function of the following:

- Forehearth length, width & depth
- Tonnage
- Glass temperature and hence glass viscosity

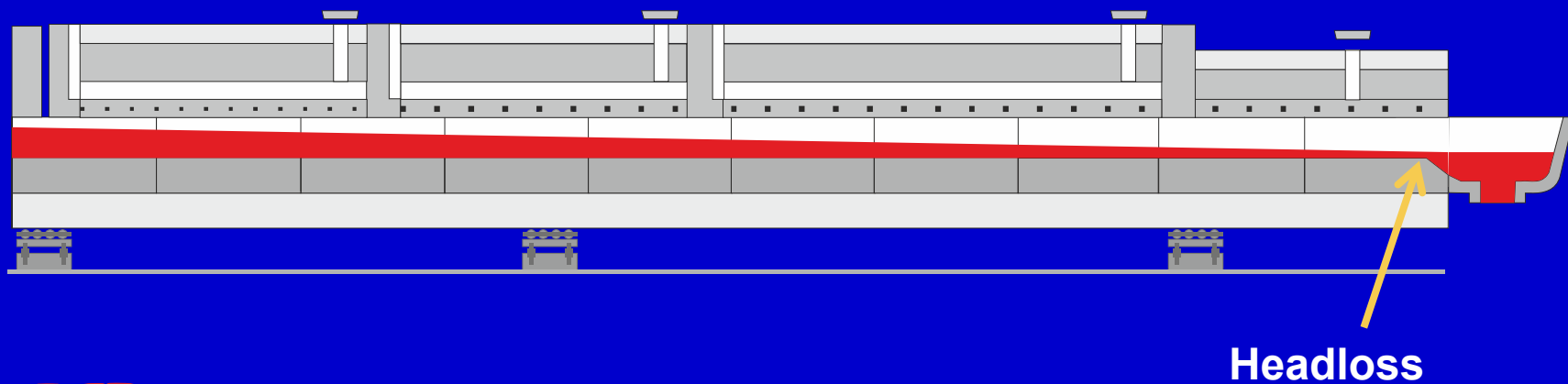

Headloss – do not ignore it

Do not ignore this important design element!

It may only be more noticeable at higher tonnages but excessive glass headloss can result in gob weight instability and an inability to obtain the required gob weight.

PSR include headloss calculations for every forehearth quoted.

We recommend that head loss should not exceed more than 25mm.

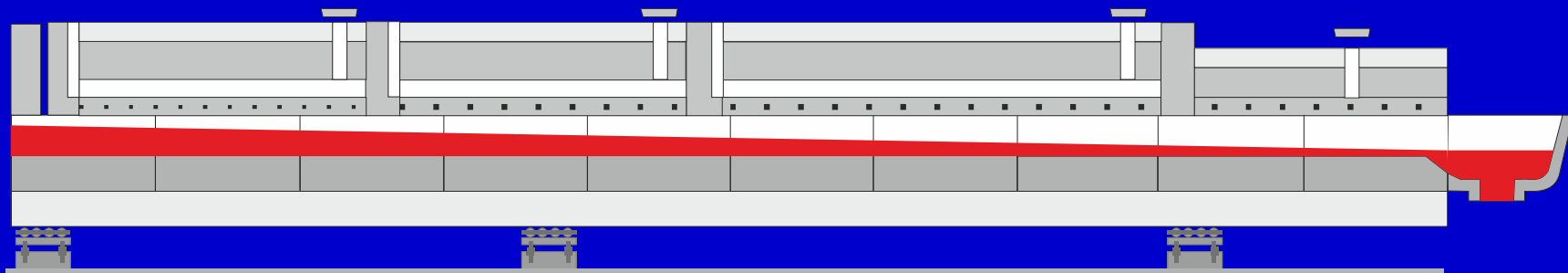

Headloss – sloping the forehearth

Head loss can be partially alleviated by sloping the forehearth.

PSR recommend a maximum incline of 19mm.

Too much incline can result in the glass flowing over the top of the channels when tonnage is reduced.

Frequent changes to forehearth incline should be avoided so as not to damage the channel joint at the forehearth entrance.

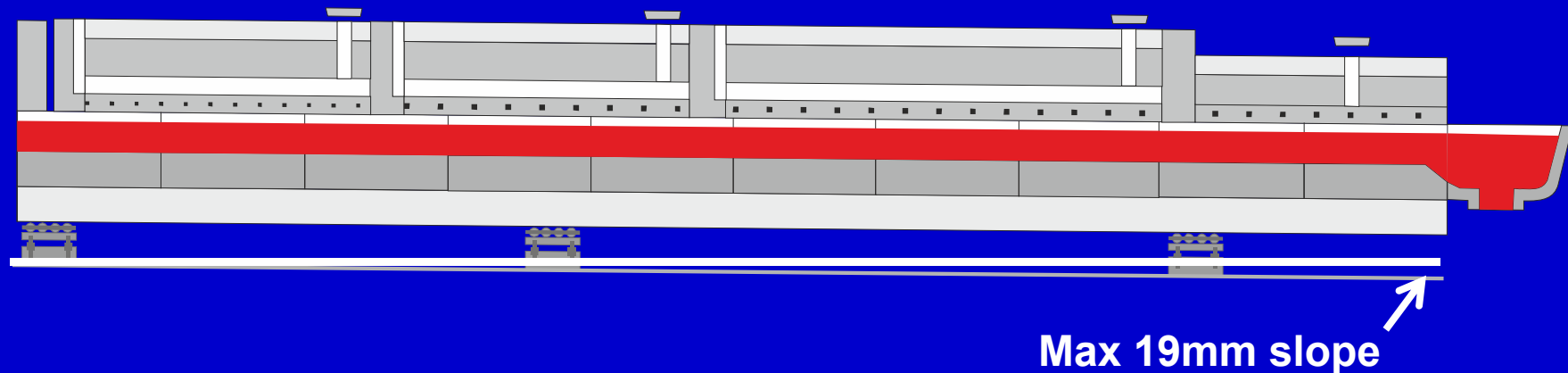

Headloss – fix it at the design stage

Headloss can also be alleviated by correct specification of the forehearth at the design stage.

This involves correctly specifying forehearth length, width & depth so as to achieve the best combination for the required temperatures and tonnages.



Headloss – fix it at the design stage

Some glassmakers operate with reduced glass level on coloured glasses and although this may be an aid to thermal homogeneity it is also likely to increase headloss and reduce spout capacity.

In such cases the forehearth may have to be designed wider to overcome the increased headloss.

A larger capacity spout may also need to be installed.

3rd design element – Cooling Capacity

Cooling capacity is the ability of the forehearth or distributor to remove heat from the glass taking into account the following:

- The glass entry temperature
- The required gob (or exit) temperature range
- The required tonnage range
- The required glass colour(s)



Cooling Capacity – maximum load condition

When evaluating cooling capacity it should be calculated under the maximum load condition.

This is the situation where:

- 1.The entry temperature is highest.
- 2.The gob (or exit) temperature is lowest.
- 3.The tonnage is at maximum.

This is then evaluated for all required glass colours taking into account (in general terms) that:

- Heat transfer for amber glass is approximately 16% less than white flint glass
- Heat transfer for green glass is approximately 28% less than white flint glass
- Heat transfer for dark green glass is approximately 34% less than white flint glass



Cooling Capacity – maximum load condition

In the distributor the throat riser temperature is the critical design factor. Each individual forehearth entrance temperature must be calculated separately based upon the maximum combined load between it and the throat riser.

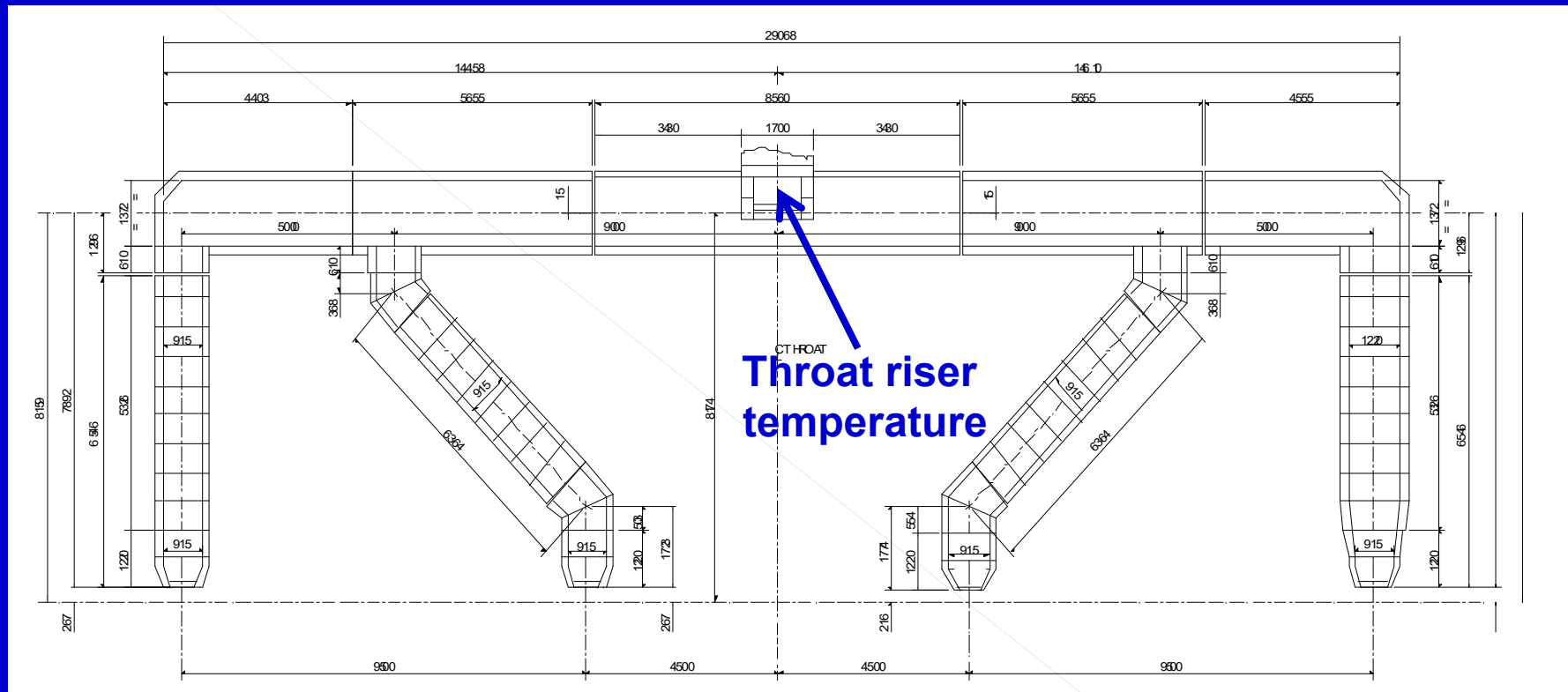

Cooling Capacity – thermal homogeneity

The cooling capacity calculation must also take into account that the exit temperature must be steady, and must have an acceptable degree of glass thermal homogeneity as measured by either the 9-point or the 5-point thermocouple grid. This requires proper care and attention to the cooling capacity requirements of the forehearth.

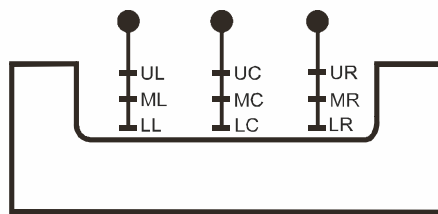

9-point grid

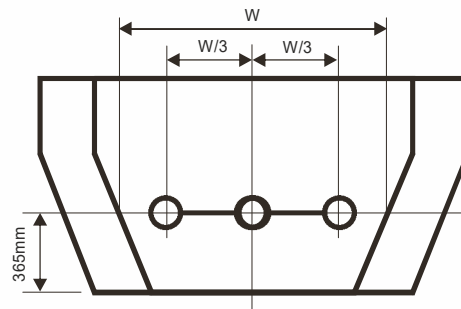

PSR standard thermocouple positions

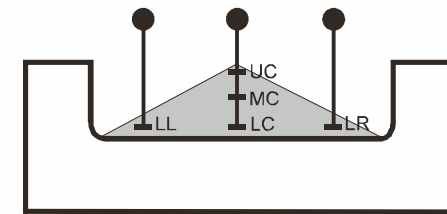

5-point grid

Heating Capacity

Heating capacity calculations must also be carried out to ensure that the system has the capacity to achieve the maximum gob (or exit) temperature at minimum tonnage.

The system must also be capable of maintaining temperature at times of no load during periods such as shut-down.

4th design element - Automation

Automation of the cooling system and damper movement has a massive influence on the operation of the forehearth and distributor.

We can take for granted that most modern forehearth systems have automatically controlled combustion systems.

However many still rely on manual operation of the damper movement and cooling system.

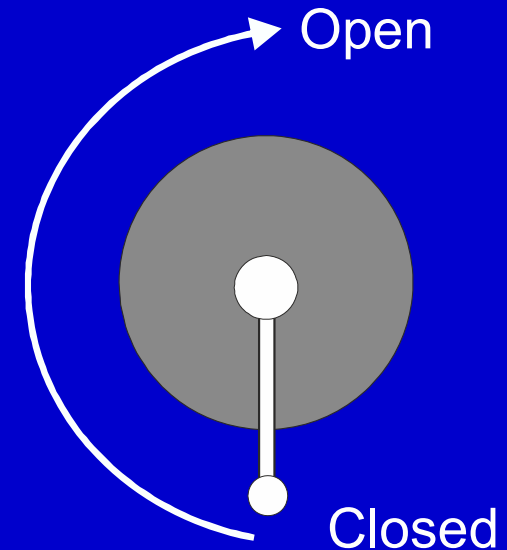

Automation – fuel savings

In recent years a number of clients have reported to us that they have achieved fuel savings as high as 50%, and sometimes more, following conversion from a manually controlled damper and cooling system to the PSR automatic System 500 cooling system. And this has taken place without any significant modification to the combustion system.

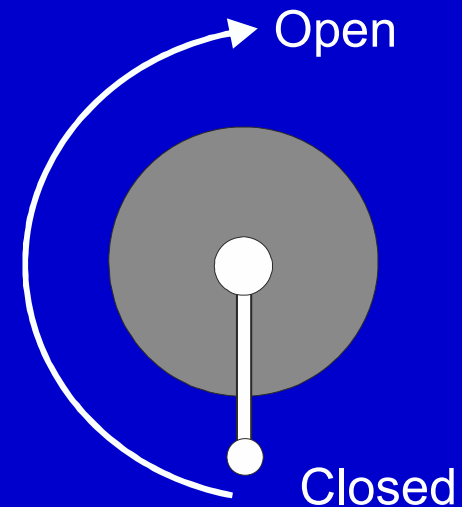

There is an explanation for this.

Automation – the PSR System 500 Forehearth

The PSR System 500 forehearth incorporates longitudinal forced air cooling passed under the central area beneath the roof blocks. The glass is cooled by radiation to the cooler refractory surface.

The flow of the cooling air is controlled automatically by a butterfly valve in the cooling air ducting and is exhausted through the central cooling flue at the end of each zone or sub zone.

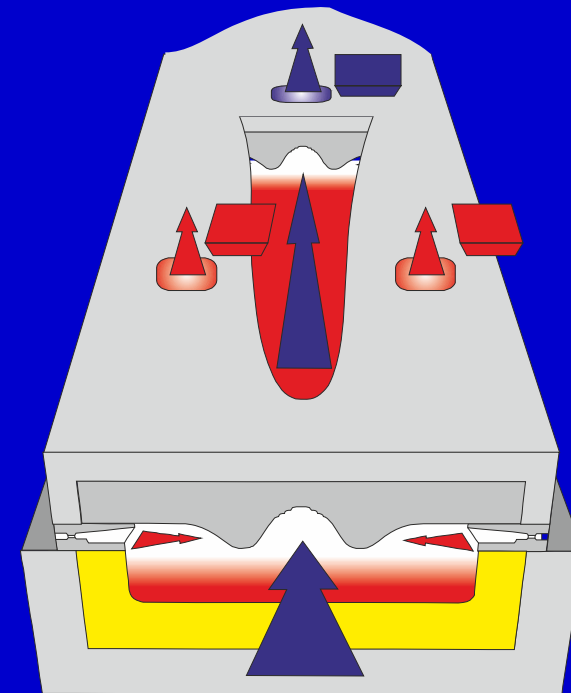

Automation – the PSR System 500 Forehearth

The combustion meanwhile takes place at the sides of the forehearth, heating up the sides of the glass flow, and is exhausted through dedicated side combustion exhaust dampers.

The position of the dampers is controlled automatically by an electric motor. The movement of the motor simultaneously moves the position of the butterfly valve to control the flow of cooling air.

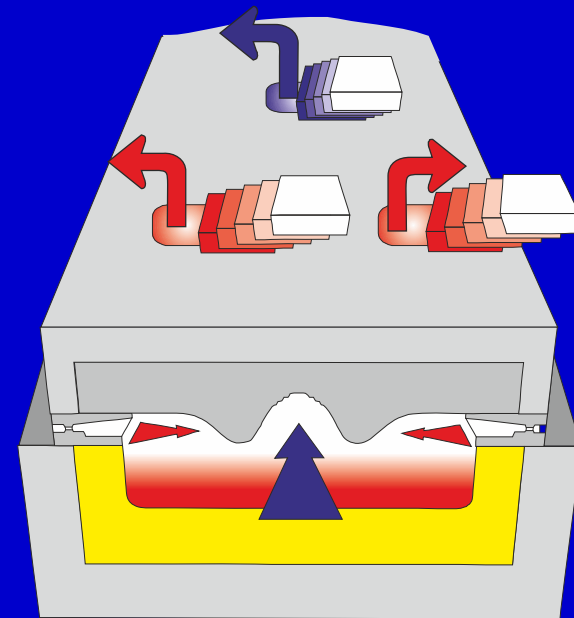

Automation – the PSR System 500 Forehearth

Figure 'A' represents the forehearth at high cooling rate.

Combustion will be at minimum and the cooling air will modulate to achieve the required glass temperature.

Fuel consumption will therefore be very low during this cycle.

The presence of the cooling air ensures that the internal forehearth pressure is maintained.

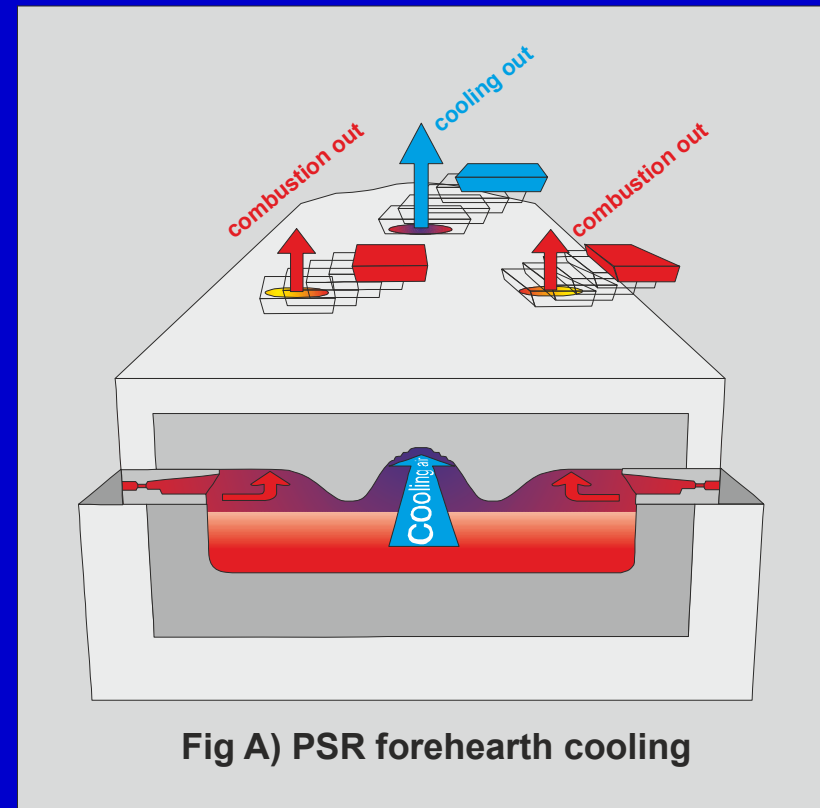

Automation – the PSR System 500 Forehearth

Figure 'B' represents the forehearth at high firing rate with minimum cooling air.

The side dampers have closed automatically, the cooling air has reduced to minimum (purge) and the central damper has closed to its minimum position, just sufficient for exhaust of the combustion gases.

Fuel usage will still be efficient because the closing of the dampers maintains a positive pressure inside the forehearth and ensures that the products of combustion are retained within the forehearth, heating up the entire forehearth width.

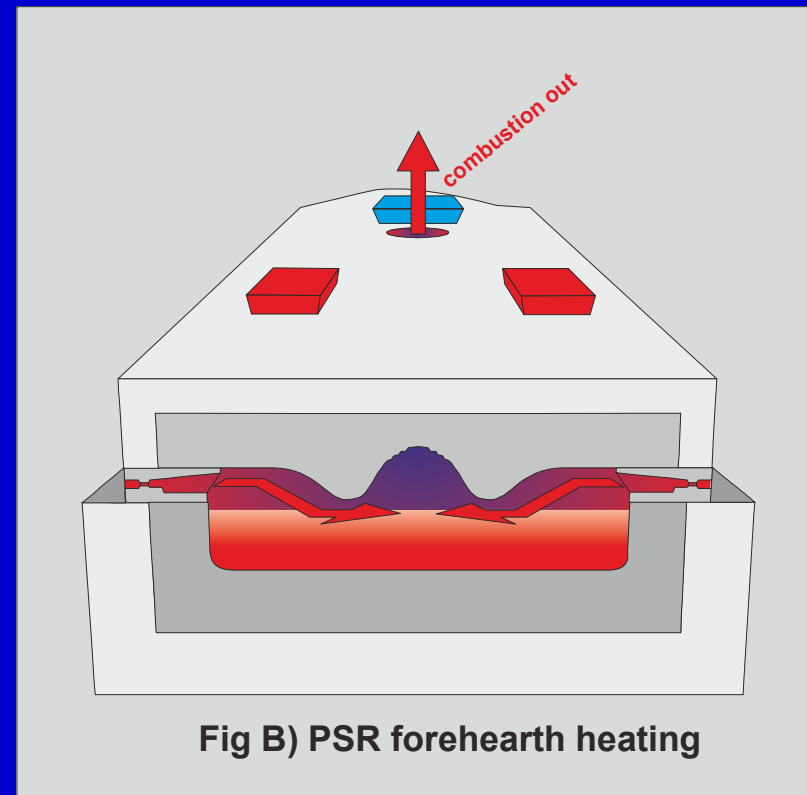

Fig B) PSR forehearth heating

Automation – manual damper control

Compare this to a typical forehearth with manual damper control as illustrated by Fig 'C'.

The dampers are opened and closed manually.

The flues are also used for cooling the glass by radiation from the glass surface to the cooler damper block or factory atmosphere depending upon the position of the damper.

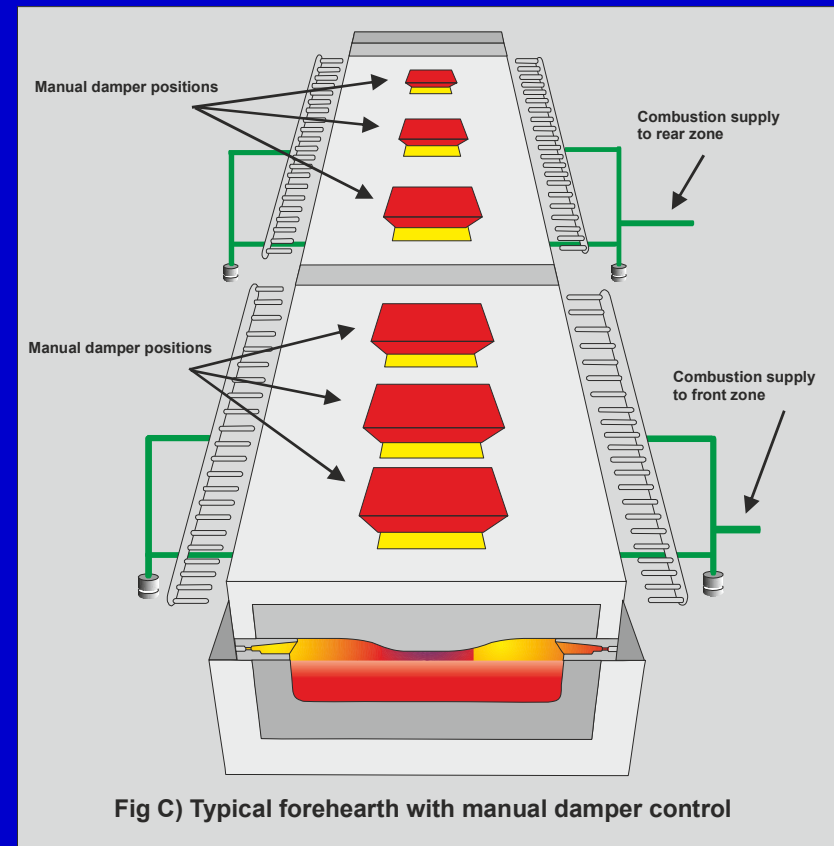

Automation – manual dampers too low

If the dampers are set too low the pressure inside the forehearth will be too high and combustion products will be forced out through gaps and peepholes in the forehearth superstructure.

In extreme circumstances the pressure inside the forehearth could exceed the pressure of the firing system, leading to back-firing down the combustion pipework.

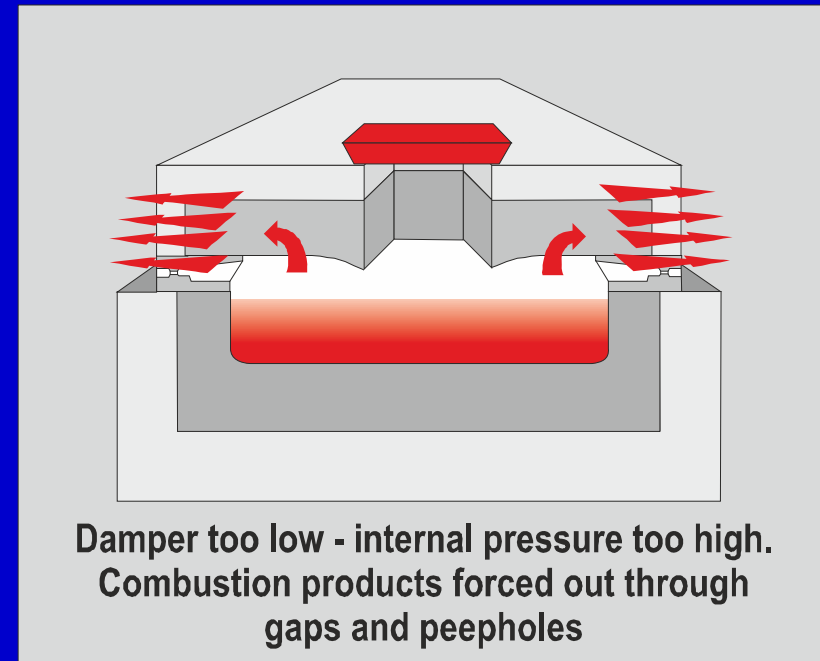

Automation – manual dampers too high

If the dampers are set too high then there will be a loss of internal pressure inside the forehearth and cold air will be sucked in through the forehearth brickwork and peepholes.

This will cause the side temperatures to fall with a consequent loss of temperature control.

The firing rate will therefore need to be set higher to compensate for the ingress of cold air and to compensate for the unwanted cooling effect.

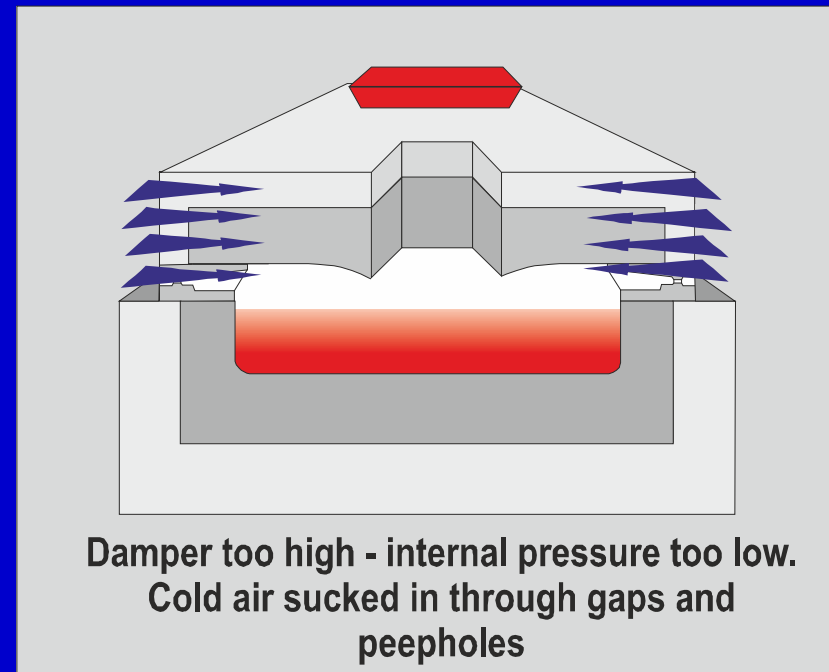

Automation – manual dampers too high

Because the firing will modulate to achieve the required temperature, manually controlled dampers will in reality never be set at the right position and will always be set higher than necessary. Therefore the internal pressure inside the forehearth will be too low, the firing rate will automatically be higher to compensate for the ingress of cold air, and energy consumption will suffer.

According to customer feed back energy consumption can be as much as 50% higher.

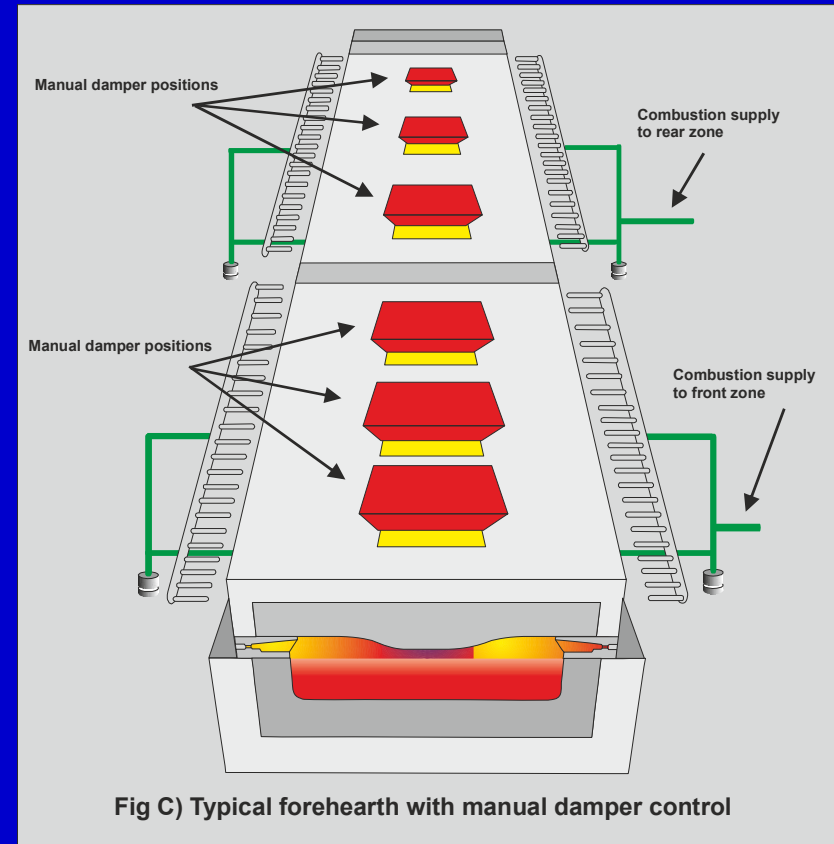

Conclusion

I have identified 4 important design criteria.

1. Residence time
2. Head loss
3. Cooling capacity
4. Automation

Failure to satisfy the first 3 may not make the forehearth or distributor inoperable but at certain times and under certain conditions production efficiency will suffer.

Failure to satisfy the 4th will be an expensive and ongoing mistake for the life of the forehearth and distributor.

Conclusion

In my personal opinion I believe that many glassmakers tolerate the inadequacies of excessive head loss or lack of cooling capacity, possibly because the effects are only encountered at high tonnages or under certain conditions.

But in today's competitive manufacturing environment it is often the last incremental percentage of production efficiency that is the difference between profit and loss.

Fixing such problems at the design stage is relatively easy and the benefits continue for subsequent campaigns as well as the current one.



Conclusion

The problem is that too often projects are driven by short term budgetary constraints rather than consideration of longer term production efficiencies.

- Capital costs can be instantly compared.
- Long term production efficiencies cannot.

And when one considers the cost of a new IS machine and complete production line ignorance of these basic design elements can be a compromising and costly mistake.

